

CHRYSLER

2001 PT CRUISER

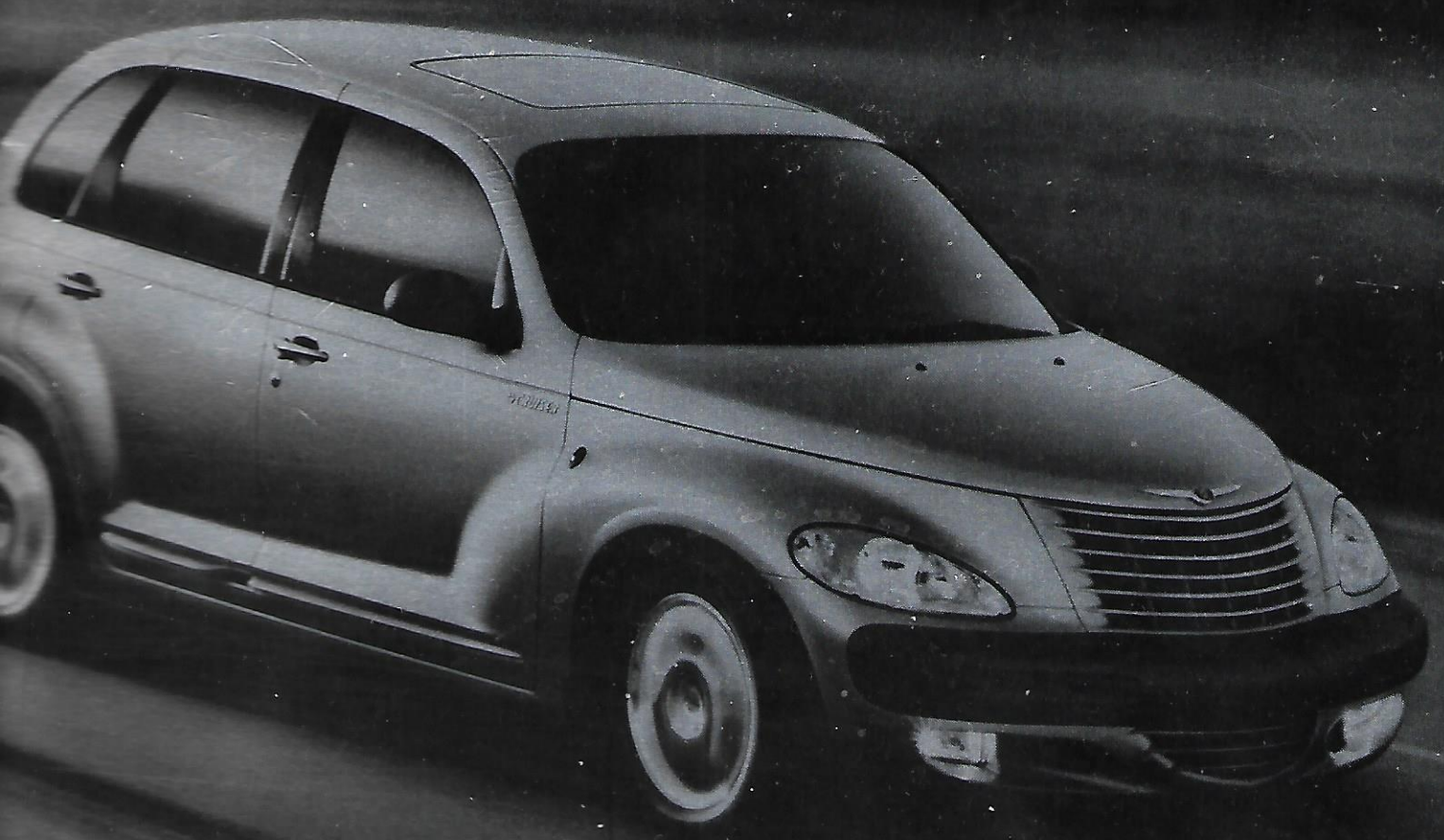

Before you have a chance to think about it, the words are already forming into three short syllables, "I want one." Rounded fenders, a purposeful grille and an elegantly sloping liftgate are heritage design cues that hearken back to an age of substance and quality. An era that produced cars you love. And still do. The 2001 Chrysler PT Cruiser is a vehicle that makes you feel that way again. Stylish. Functional. Versatile. Daring. The PT Cruiser embodies all of the qualities that make a vehicle more than just something you drive, and transform it into something you love.



PT Cruiser Limited Edition in Bright Silver Metallic

Industrial designers have been making useful, yet beautiful, objects for years. Things we use every day, like telephones, cameras, ballpoint pens and mechanical pencils, with little thought given to the era that spawned them, or the people who designed them. Industrial designer Henry Dreyfuss elevated the workhorse steam locomotive to legendary status when he sheathed the Hudson J3 in a distinctive cowling that made it look more streamlined, more powerful, more capable of making the trip from New York to Chicago in only 16 hours. It was 1938, deep in the heart of the golden age of Art Deco. A time when the future was clearly visible... and what we saw was beautiful. When Walter P. Chrysler wanted

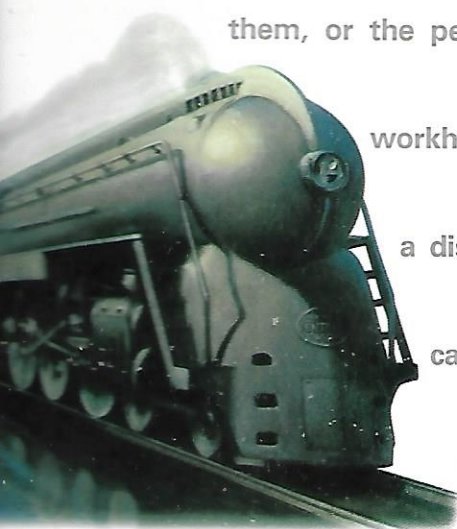

CLASSIC STYLE

"a bold structure, declaring the glories of the modern age," he hired William Van Allen to design and build

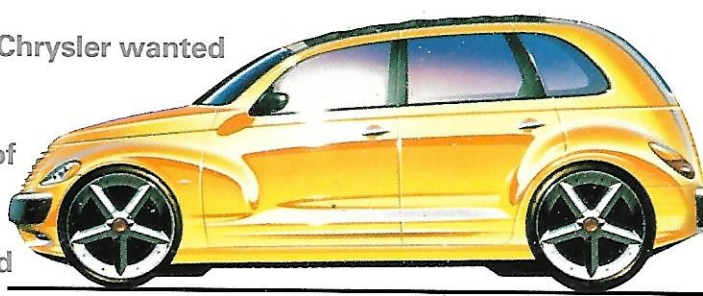

the Chrysler Building. From its massive foundation to at its apex, the Chrysler building, in all of its Art Deco scraper, defining and celebrating an age of substance, kind of inspiration that went into creating the 2001 create a technologically advanced vehicle that would with a bold, distinctly American look. From its expressive hood to its chrome pushbutton elegantly sloping liftgate, PT Cruiser is reminiscent of a time-honored era in automotive history. Inside, you'll discover a world of

the exotic and intricate stainless steel cladding glory, is easily the world's most identifiable skyscraper, prosperity and timeless beauty. It was just this Chrysler PT Cruiser. Chrysler designers wanted to be a celebration of this classic era. A vehicle powerful grille, rounded fenders and smooth, door handles, bullet-shaped taillamps and functional versatility, comfort and safety.

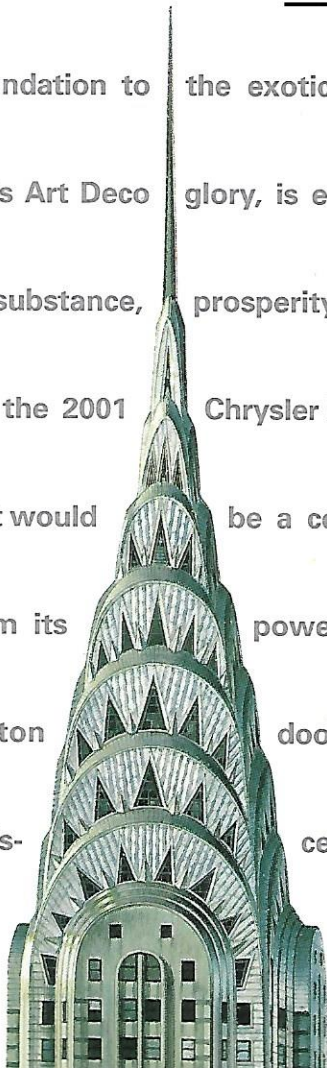

PT Cruiser is a vehicle that, as Walter P. said, "declares the glories of a modern age"



"If subversive means 'to threaten the established order of things,' then the PT Cruiser is subversive, because that's what the PT Cruiser is going to do."

—David E. Davis Jr. • Editor and Founder, *Automobile Magazine*





PT Cruiser Limited Edition in Bright Silver Metallic





"It's called the PT Cruiser, and it's fortified with all the charm, attitude, personality, chutzpa, charisma...that most five-seat cars under \$20,000 are lacking."

—*Car and Driver* • July 1999

PT Cruiser Limited Edition in Bright Silver Metallic





SRS AIRBAG

PT CRUISER

1035

POWER
OUTLET
20V 20A

PT Cruiser Limited Edition interior with Dark Tan leather-trimmed seats





PT Cruiser Limited Edition interior with Dark Taupe leather-trimmed seats

ALL OF THESE THINGS WI

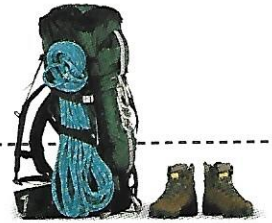
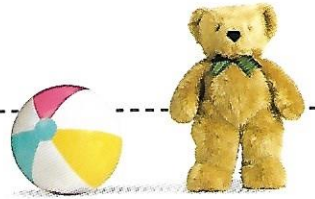

FIT INTO THIS PT CRUISER.

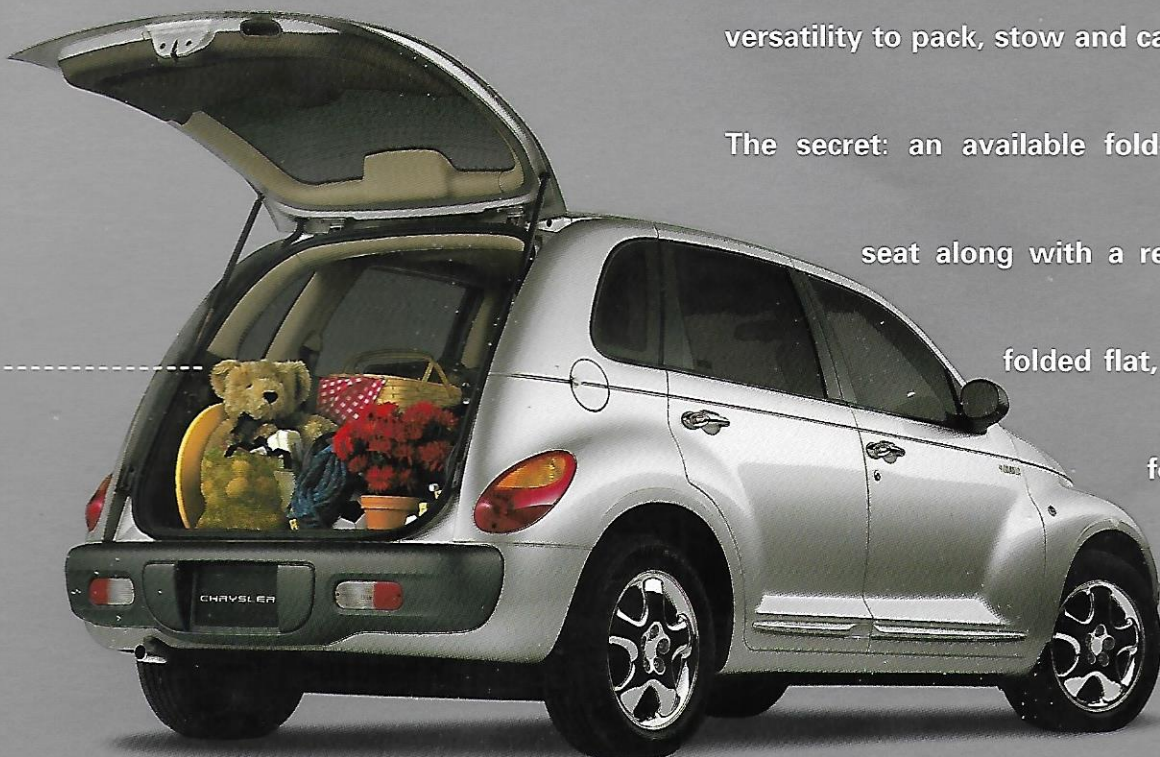

It is a pictorial paradox. Will it really all fit? The

answer is a resounding "yes." With 120.2 cubic feet

of interior space, PT Cruiser offers nearly endless

versatility to pack, stow and carry almost anything.

The secret: an available fold-flat front-passenger

seat along with a rear seat that can be

folded flat, folded and tumbled

forward or removed

depending on just

what it is you want

to carry and how much room you need. Take along

passenger to help you load and unload, and you still

have a spacious 64 cubic feet of interior cargo room

with the rear seat removed.

AT THE SAME TIME.

People value their space almost as much as they value their possessions. Inside PT Cruiser, you have the space to take along many of your possessions, or pick up some new ones. The seats can all be manipulated to suit your needs. The 65/35 split-folding rear seat can fold flat, fold and tumble forward or, should the

LIMITLESS VERSATILITY

need arise, you can remove them completely—individually or in tandem—quickly and easily, and roll them out of the way. With the available fold-flat front-passenger seat, you can fold it down to carry long items. All told, you have 120.2 cubic feet of interior space to utilize. Fold down all the seats and PT Cruiser is the perfect vehicle whether you're a backpacker or rock-climbing aficionado, a home gardener carrying flats of flowers or a handyman who needs to carry a lot of tools. The

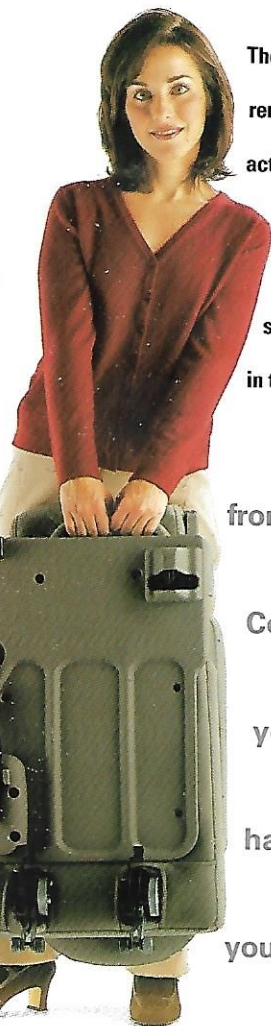

The 65/35 split-folding rear seat can be removed easily, with no tools. Simply actuate the quick-release latches and pull the seat up. Rollers allow the seat to be rolled away for easy storage. Carrying handles are built in to aid in their removal.

standard multiposition rear shelf panel extends the load floor from instrument panel to liftgate. Whatever the task, PT Cruiser will meet your demands. Concerned about that "all work and no play" adage? Fold down the backseat and you and a traveling companion can pack up for a week's vacation. But you don't have to fold or remove the rear seat for PT Cruiser to be useful. Behind the backseat, you'll find a full 19 cubic feet* of cargo room—more than the trunk of most large sedans—enough provision space for a weekend getaway for you and four friends. It's also perfect for running errands around town. Picking kids up from school. Stopping by an estate sale. Heading out with friends for dinner and a movie. Or just going to work



Room for 5, plus cargo

4 people, table (folded seat) and cargo

2 or 3 people, table and cargo

Driver and long items (skis?)

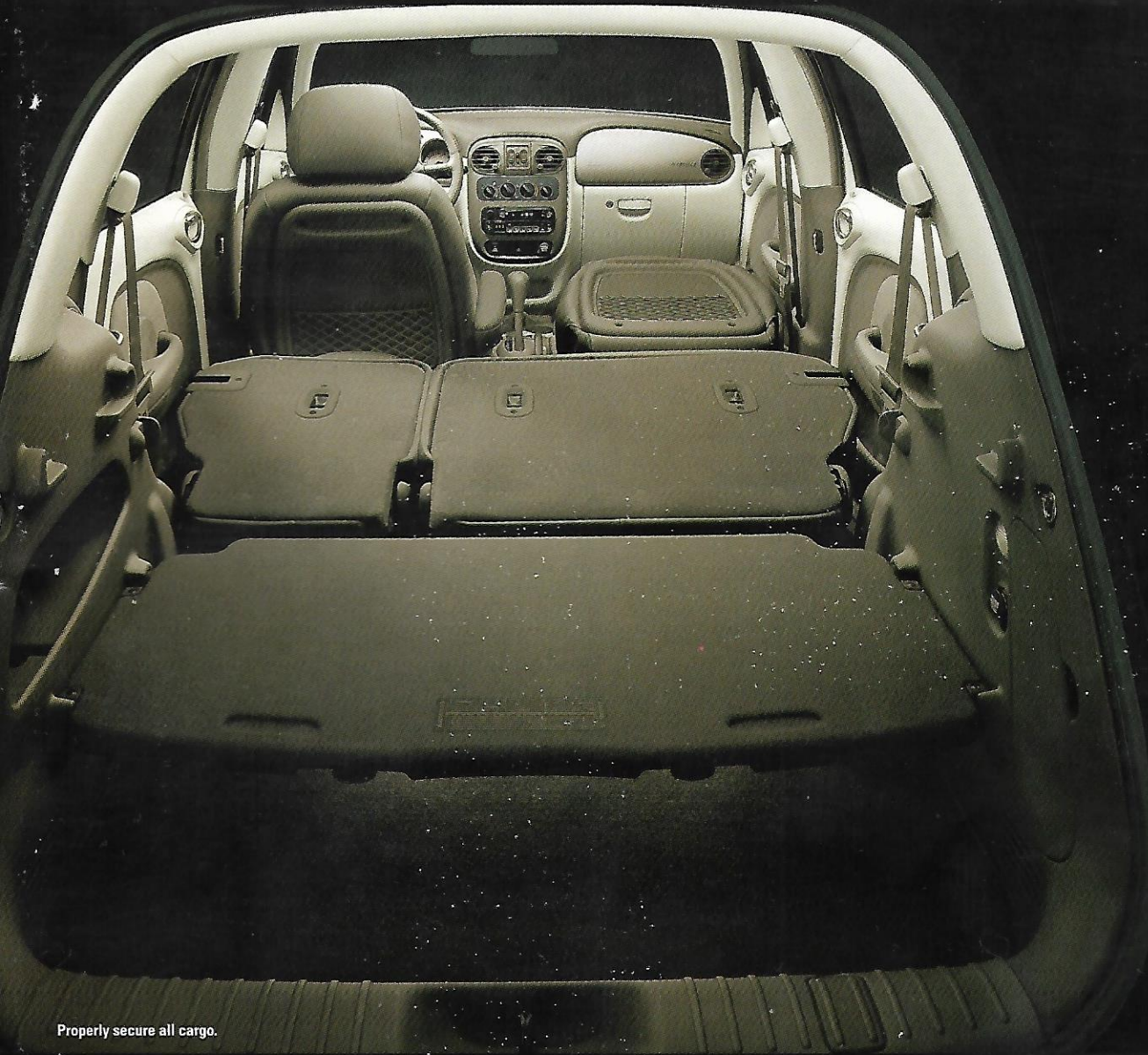

Properly secure all cargo.



Driver, table and weird shapes

Driver, table and tall goods

Driver and almost anything

Driver and everything



When you pull up on the Chrysler winged badge on PT Cruiser's liftgate, you open a world of possibility.

The abundant cargo capacity is only part of the story. The standard multiposition rear shelf panel is where

PT Cruiser really flaunts its functionality. And it's simple to use, so no act of prestidigitation is required to

maneuver the rear shelf panel securely into any of its functional positions. With the

rear seat up and the liftgate closed, it acts as a security screen for valuables. Perfect

FUN AND FUNCTION for keeping a purse or briefcase out of sight. Fold

the rear seat down and the rear shelf panel can be adjusted to the same height as the

back of the seat, extending your flat load floor. You can carry objects up to eight feet

long with the liftgate closed! And you don't have to be too gentle with it, because in certain positions the rear

shelf panel can support up to 100 pounds. Great for carrying skis to the lodge or moldings and a ladder for a

weekend home-improvement project. Flip the rear shelf panel up against the upright rear seatback, and you

can take advantage of the four built-in grocery bag hooks. Those bothersome plastic grocery bags won't be

able to spill their contents all over any more. Turn the rear shelf panel over to expose its noncarpeted side.

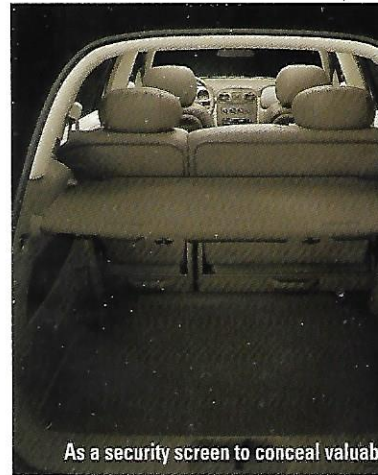

The multiposition rear shelf panel is the very model of functionality. Ready for you when you need it. Flip it over and it protects your floor from messy cargo. Place it at the same height as the folded rear seat for an extension of the flat load floor. Or hang your grocery bags on the four built-in hooks.

Placed on the rear floor, it protects your carpet from messy cargo like flats of plants or paint cans. The rear

shelf panel really shows its fun side when it becomes the perfect party platter. Leave the liftgate open, pull

the shelf to the rear, flip the shelf leg down and load it up with food and beverages. Whether you're

As a flat floor extension with rear seat folded down*

As the pregame gathering place



As a floor protector to haul wet or dirty goods

As a retainer, with hooks for gear



Properly secure all cargo. *Do not load objects over 100 pounds, drive vehicle with liftgate open or use shelf panel as a seat. †Shelf panel is not a load-bearing divider.

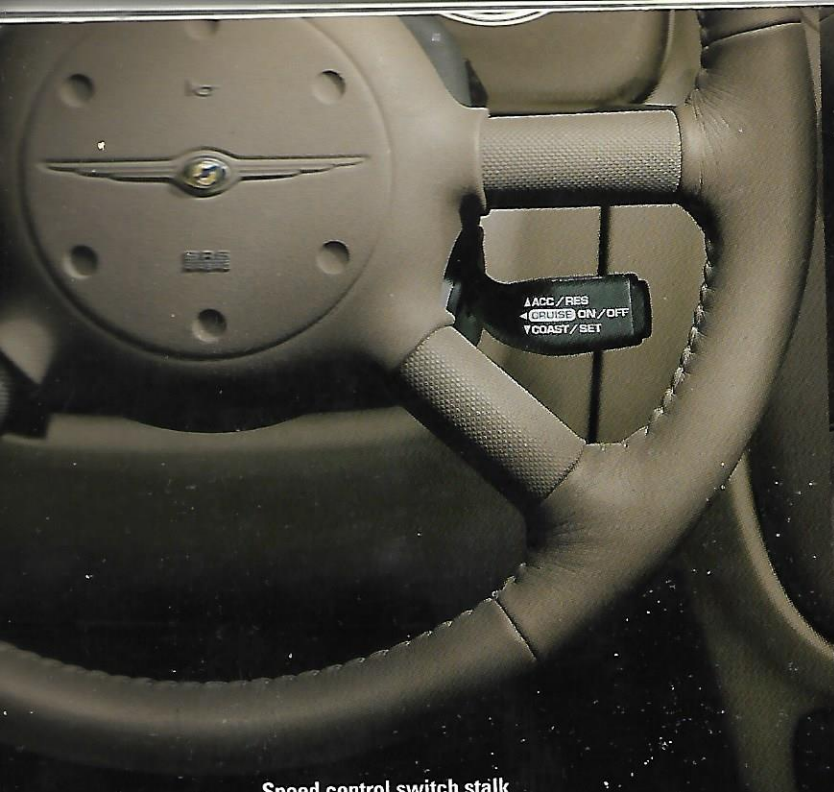

Speed control switch stalk

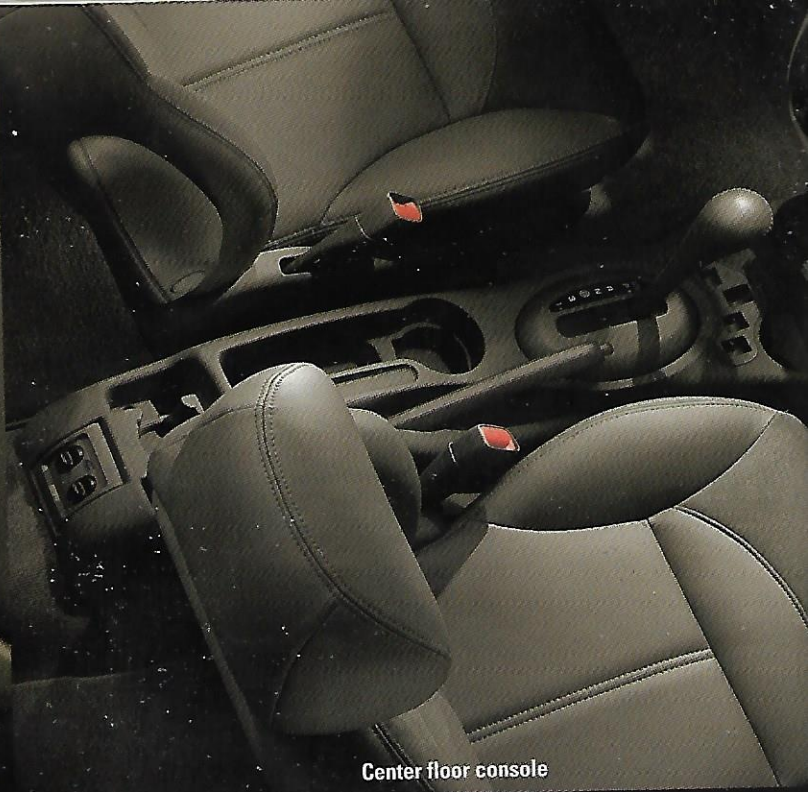

Center floor console



Driver's seat folding inboard armrest

Sliding sun visor



Large storage pockets

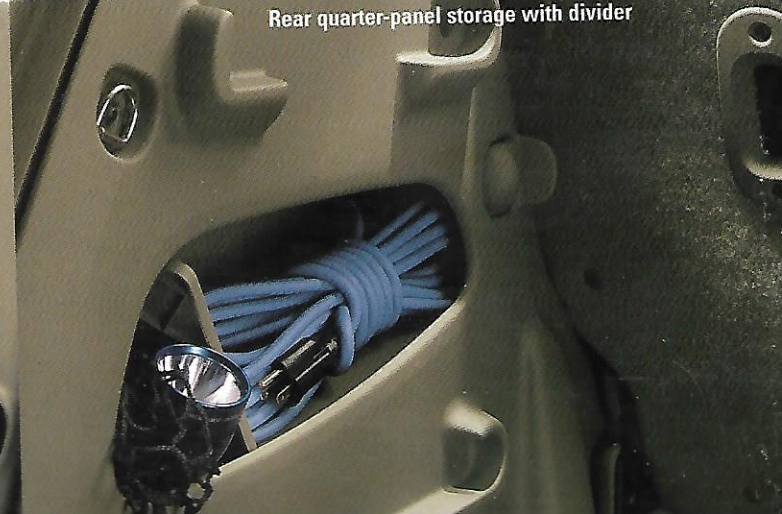

Rear quarter-panel storage with divider

THOUGHTFUL FEATURES

PT Cruiser is exquisitely engineered to place what you want where you want it. The available speed control stalk is mounted a fingertip touch away from the steering wheel. The center console has space reserved for items you need for your morning commute, including four cup holders, a pen and pencil tray, letter slot and coin holder. You'll find the available 12-volt power outlet in the rear cargo area, convenient for plugging in a cellular phone in an emergency or a portable compressor, to blow up footballs and beachballs, at your next tailgate get-together. The inboard armrest on the driver's seat is just the right height and folds out one way when not in use. When the sun seems to be working diligently to get under your eyes, you'll appreciate the way the sun visors slide for extra side window coverage. Large storage pockets in the front doors will hold more than just maps.

5E 69+

Available overhead console

The available overhead console displays the temperature outside your PT Cruiser and also helps you keep a steady course with the built-in compass. Dual interior lamps provide light when you need it with a single touch. The switch for the available power moonroof also finds a conveniently located home in the overhead console.

Driver's seat with available leather

Available cargo net

A rear quarter-panel storage compartment is a happy surprise. It has a movable divider for added versatility that also acts as a cover for increased security. The available cargo net will help you utilize the cavernous cargo capacity of the PT Cruiser more efficiently. Snap loops in each corner of the cargo net can be connected to tie-down loops on the rear trim panels just behind the rear seats, and at the upper shelf panel position near the liftgate. The net can also be hung from the bag holders on the shelf panel when it's in the upright position. PT Cruiser's chair-like driver and front-passenger seats provide support and comfort for a long commute or an extended vacation. The available leather-trimmed seats (included on Limited Edition) add an air of luxury. An available power driver's seat height adjuster puts you in command of the road. Four-way adjustable head restraints are included with leather-trimmed seats, and add an extra measure of comfort.





Rear-seat ventilation ducts



Large locking glove box



Letter holder in center console



Available underseat storage drawer*

THOUGHTFUL FEATURES

Since we believe that all passengers in a vehicle should be comfortable, we've added rear-seat ventilation ducts that run through the center console to direct airflow to passengers in the backseat. The large glove box has enough room for the little odds and ends that accumulate inside a car, and has molded-in pen and tire gauge holders for easy access. You'll find a convenient letter holder at the front of the center console, so you can keep your correspondence, intimate and otherwise, close at hand. An available storage drawer* resides under the front-passenger seat and holds up to six cassettes or eight CDs, so you'll have ready access to your favorite music. The center stack between the driver and front passenger places climate control knobs, power window switches and the sound system controls within easy reach.



Center stack controls



Available power, heated, folding mirrors



Theater-dimming lamps

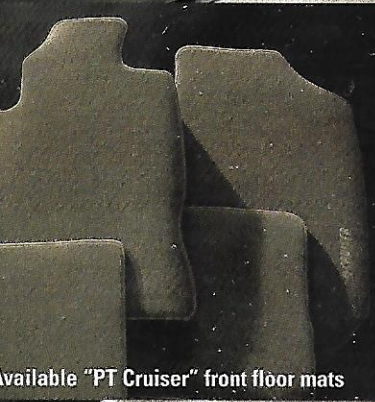

Available power mirrors heat up to melt away ice and snow. Theater-dimming lamps illuminate the interior. Available "PT Cruiser" embroidered front floor mats add an elegant touch.

Available "PT Cruiser" front floor mats



Available front fog lamps



Premium instrumentation with tachometer



Available power moonroof



Available roof rack

Integrated with the front fascia, available fog lamps (upper right) increase your ability to see and be seen through fog and haze. Chrome rings encircle the three instrument panel gauges, including the 8,000-rpm tachometer. Black graphics are displayed on an off-white background, adding a period touch and improving visibility. A single touch of a button opens the available power moonroof, bathing PT Cruiser's cabin in the warmth of sunlight. The moonroof also partially opens to vent the cabin on days when you want some fresh air, but it's not quite so sunny. Add even more versatility and cargo capacity to your PT Cruiser with the available roof rack. Stylish and functional, the roof rack has a load capacity of 220 pounds and, when not in use, the crossbars slide to the rear of the vehicle, giving the racy appearance of a spoiler. Best of all, crossbar adjustment is a one-person operation, making it easy and convenient to use.

"While practicality may be its strong point, it's the styling of the PT Cruiser that will set it apart."

— AutoWeek • May 3, 1999





PT CRUISER

PT Cruiser with Touring Group in Black





PT Cruiser interior with Luxury Touring Group in Dark Taupe/Light Pearl Beige



**"Underneath this radically designed throwback to the '30s
breathes a practical economy car." — *Car and Driver* • July 1999**



PT Cruiser in Aquamarine Metallic



“...colour panels on the dash that coordinate with the exterior body colour, bright ringed circular gauges recessed into the instrument panel (again, a tribute to models of yesteryear)...” — *The Toronto Sun* • February 21, 1999



PT CRUISER

SRS AIRBAG

FM 103.5

POWER
OUTLET
12V-20A

POWER
OUTLET
12V-20A

PT Cruiser instrument panel with Aquamarine Metallic inserts

Practical. Functional. Versatile. All useful qualities you appreciate. But driving is supposed to be fun, too.

You want a vehicle that can take the curves and straighten them out. PT Cruiser is it. Under that exquisite



body is a car that wants to be driven. Chrysler engineers injected a healthy dose of roadability into PT Cruiser, making it more than just a practical daily driver. The rear

suspension's Watt's linkage helps constrain lateral movement of the twist beam rear axle so there

is less side-to-side variation for more precise handling. The twist beam causes the

tires to remain vertical relative to the road

during cornering, enhancing rear tire cornering

traction for good handling. Ample

rear suspension travel of 8.5 inches provides a comfortable ride and minimizes "bottoming out," even

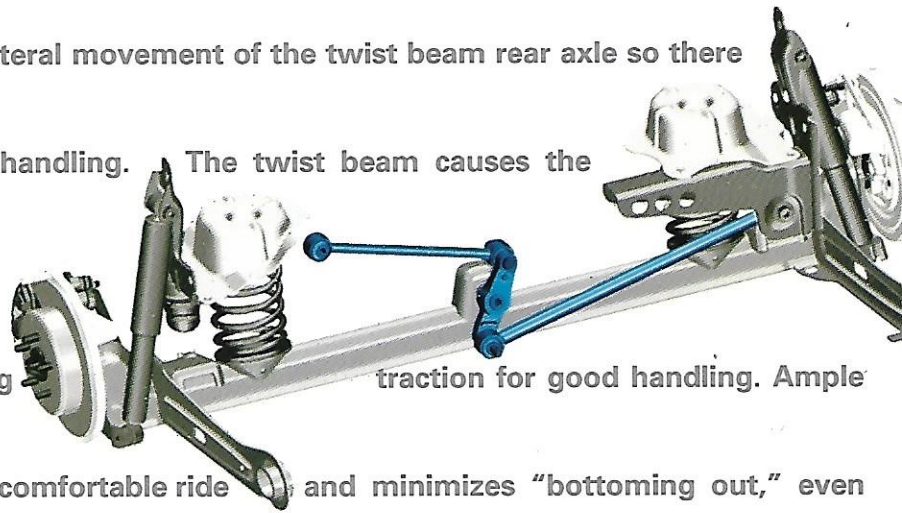

HANDLING

when PT Cruiser is loaded with people and cargo. For improved handling, the available

Touring Group and Luxury Touring Group offer a touring-tuned suspension and 16-inch all-season touring

tires. And, since stopping is as important as cornering and acceleration, PT Cruiser is equipped with

standard front disc/rear drum brakes. The front rotors are large diameter (top and left) to

ensure ample stopping ability, and

air scoops in the front fascia

provide cooling for

the front brakes, contributing to

operation. For the more performance-minded, four-wheel disc antilock brakes with Low-

Speed Traction Control are also available to help maintain steering control in hard braking

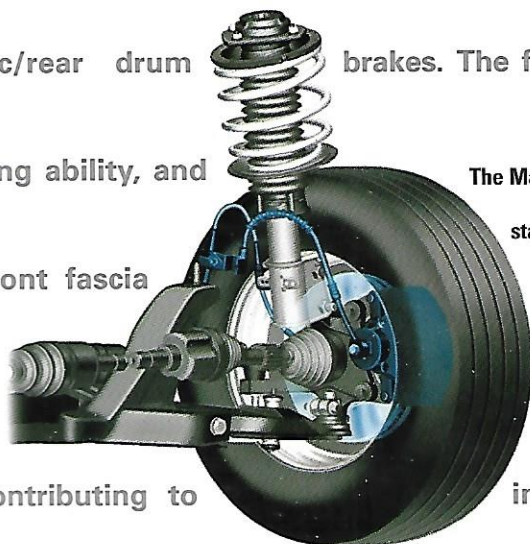

The MacPherson strut independent front suspension, stabilizer bar and firm springs contribute to responsive steering and excellent handling by reducing body lean during cornering.





You remember the feel of a cue-ball gearshift knob. How it filled the palm of your hand. Nothing fancy, really. But somehow that plain, white ball with numbers etched into it atop a chrome shaft was the most beautiful thing

you'd ever seen — and felt. It gave you a complete feeling of power. Of control. Five speeds, just waiting for you to engage them. PT Cruiser gives you that feeling again. Its five-speed manual transaxle is controlled by a Light Pearl Beige shift ball on top of a chrome shaft. Heritage design. It takes you back and, at the



same time, propels you forward. A cable shift mechanism provides short throws and crisp operation through all five gears. A self-adjusting clutch mechanism reduces initial pedal effort and maintains consistent effort throughout the life of the clutch. PT Cruiser's 2.4-liter DOHC 16-valve four-cylinder power plant offers up 150 horsepower at 5,600 rpm and 162 pound-feet of torque at 4,000 rpm. You'll better appreciate those numbers when you step on the gas pedal to climb a hill or pass another vehicle. To help keep the rev-happy engine quiet, a system of counterrotating balance

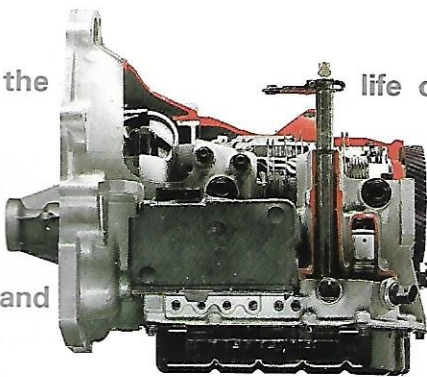

shafts counteract second-order imbalance, the predominant cause of four-cylinder engine vibration. Aluminum alloy pistons help to keep the idle smooth. An available four-speed automatic transaxle's wide-spaced gear ratio gives PT Cruiser brisk acceleration and smooth highway cruising. A leather-wrapped shift knob is included on Limited Edition and with the available Luxury Touring Group.

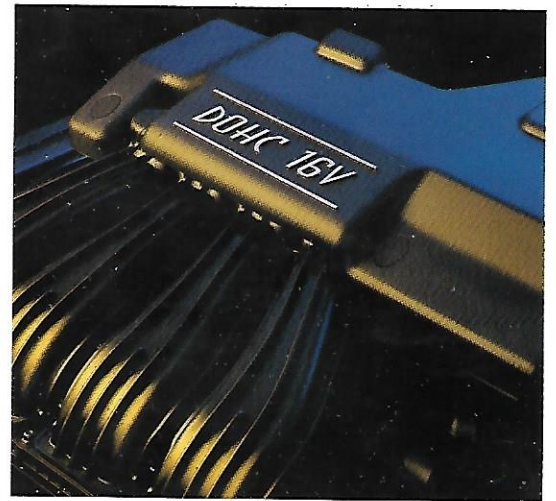

PT CRUISER POWER

engine vibration. Aluminum alloy pistons help to keep the idle smooth. An available four-speed automatic transaxle's wide-spaced gear ratio gives PT Cruiser brisk acceleration and smooth highway cruising. A leather-wrapped shift knob is included on Limited Edition and with the available Luxury Touring Group.

acceleration and smooth highway cruising. A leather-wrapped shift knob is included on Limited Edition and with the available Luxury Touring Group.



gear ratio gives PT Cruiser brisk acceleration and smooth highway cruising. A leather-wrapped shift knob is included on Limited Edition and with the available Luxury Touring Group.



The refined intake manifold runner and plenum configurations, combined with a large volume air intake system, help provide abundant low-speed torque while minimizing rumble.

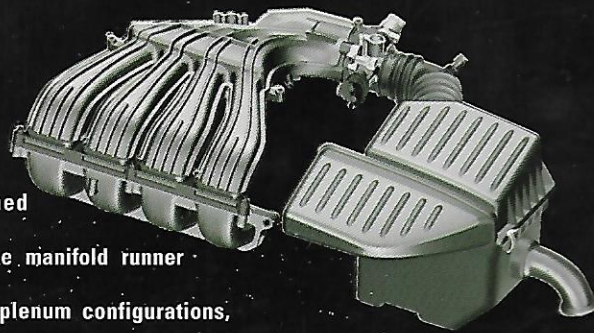

As beautiful as it is, PT Cruiser is no china doll. PT Cruiser's overall body structure contributes to solid ride and handling characteristics through rigid support, while minimizing noise transmission and providing a high level of impact protection. A unique transverse beam connects the center pillars

STRUCTURE

and ties into the floor pan at the center tunnel.

The beam helps protect occupants in the event of a side-impact collision, increases body stiffness to improve

and decrease interior noise and provides a rear mounting surface for the front seats. Welded joints have been refined in the center pillars, door sills and roof rails, making

a major contribution to torsional stiffness. The Watt's linkage has softer bushings at its linking

points, which limits the transmission of noise and harshness into the passenger compartment. The Watt's linkage also allows smaller wheel wells, making for greater overall interior volume. Thanks to tight body seals



and many acoustic treatments, PT Cruiser offers a surprisingly quiet ride. A tightly sealed body shell helps lower wind noise and road noise. A full hood seal, cast foam instrument-panel silencer, and cavity baffles inserted between body panels before welding and expanded by the paint-baking process are just

a few of the acoustic treatments

to help keep PT Cruiser's

steel beams in the

side-impact protection

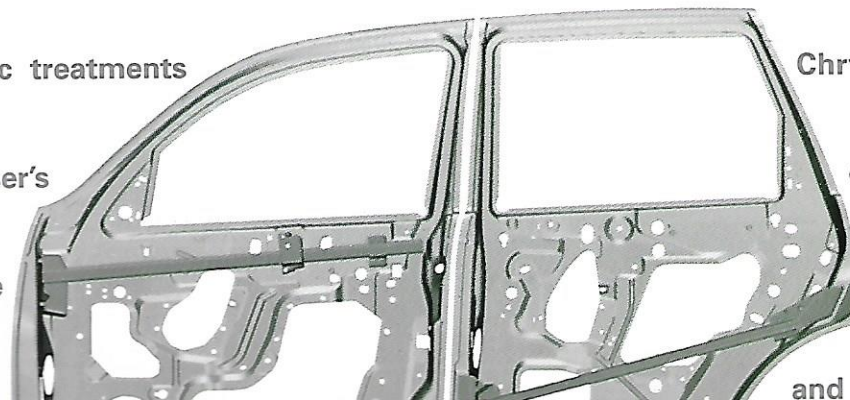

Chrysler engineers utilized

cabin quiet. Longitudinal

doors offer dynamic

and also help prevent door

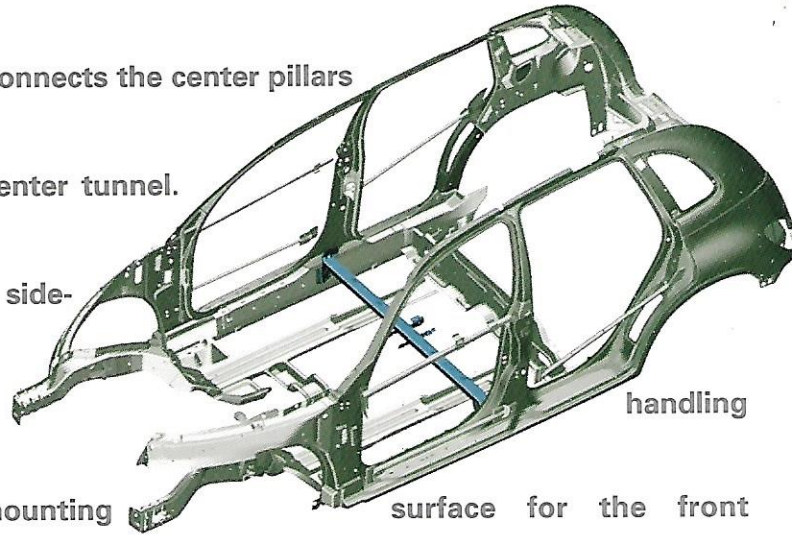

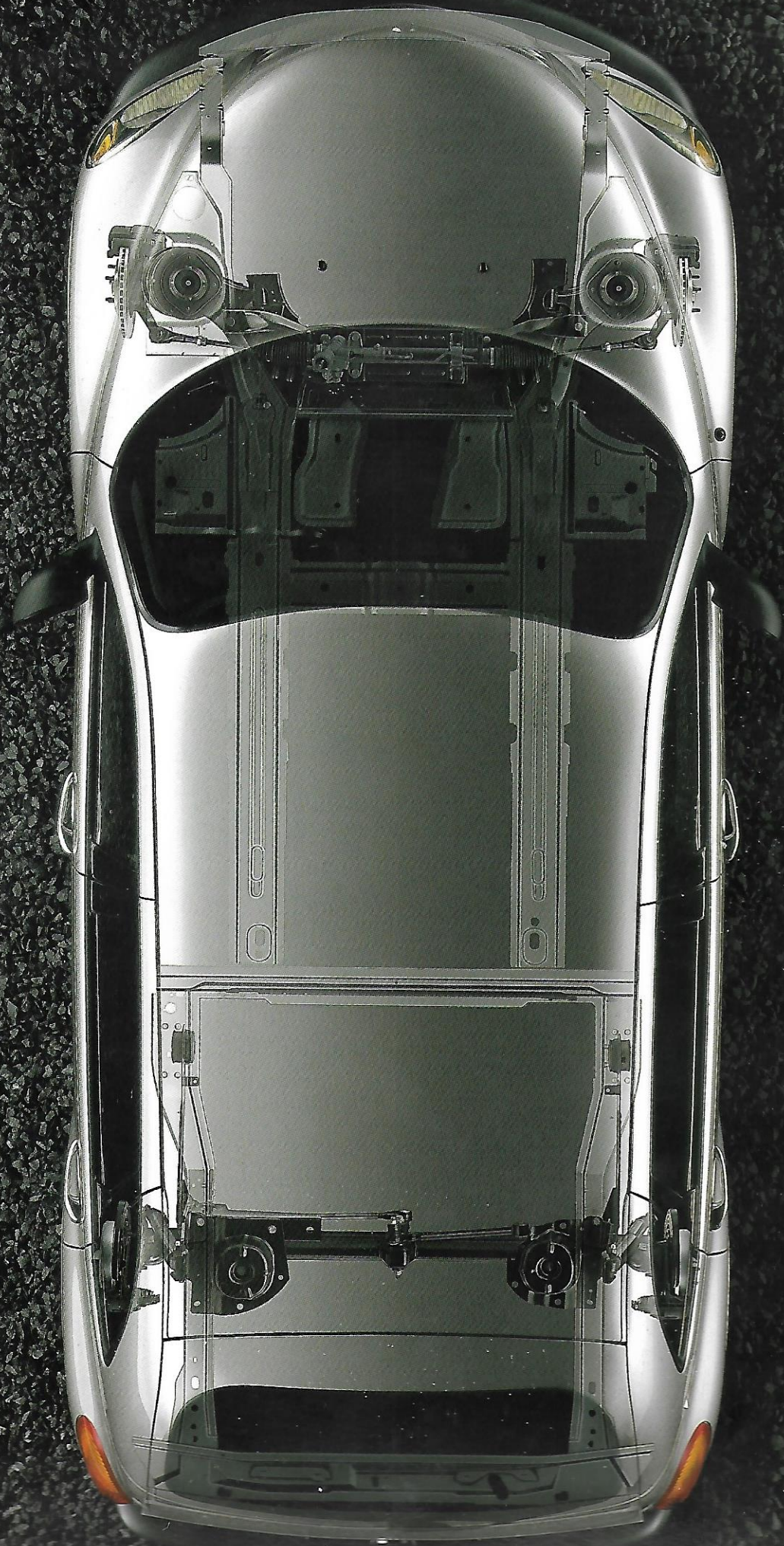

An errand here and a commute there. It all adds up to spending a large percentage of our time in our vehicles. The time spent behind the wheel should be time spent feeling safe and secure. PT Cruiser offers many advanced safety and security features to help you feel safe. Next Generation driver and front-passenger front air bags,* when used in conjunction with front three-point Unibelt seat belts with pretensioners, will help you feel more secure, even if you're never involved in an accident. You will feel better just knowing they're there. Available front outboard side air bags* provide enhanced head and thorax protection for a properly positioned driver and front passenger in a side impact. The side air bags are included with Limited Edition,



Head-impact provisions (far left) are built into the upper trim panels, helping protect occupants' heads in the event of a collision. Knee bolsters (middle) also help absorb impact energy and work in conjunction with other safety systems, including air bags and seat belts, to help manage crash energy.

and are otherwise a separate option, because PT Cruiser meets all side-impact regulations without them.

For added safety, all three backseat passengers are held secure with shoulder belts, including the rear-center seating position. The user-ready child seat lower and top tether anchors

SECURITY

help minimize movement of aftermarket child seats. Available four-wheel disc antilock brakes with

Low-Speed Traction Control improve your ability to steer your way clear of danger in hard braking

situations by preventing wheel lockup and help you get going again on slippery surfaces. The available

remote keyless entry system provides common lock and unlock function for doors and liftgate.



It also includes a panic alarm that activates the horn and exterior lamps when

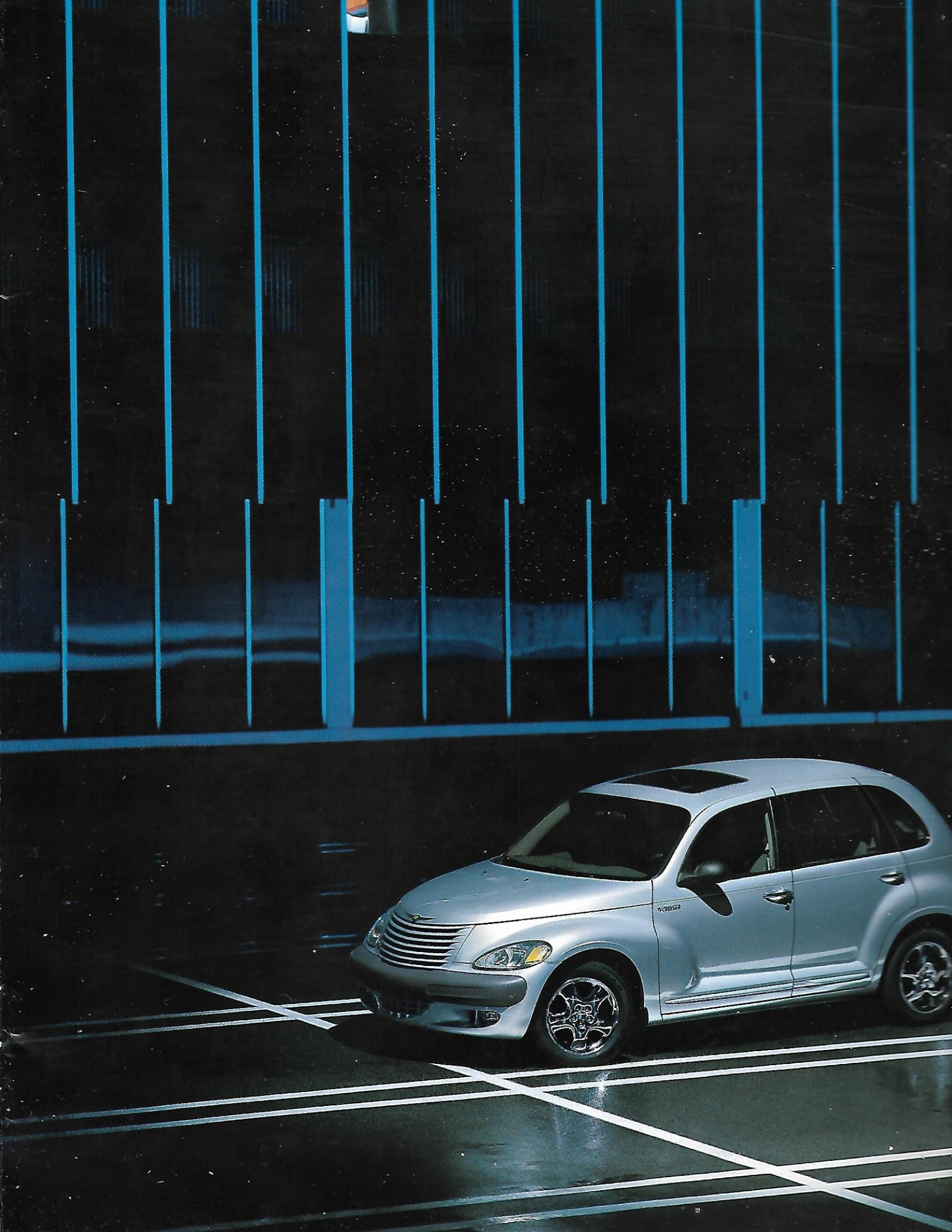

PT Cruiser comes standard with many premium features, but you may want to add options to truly make

PT Cruiser your own. PT Cruiser's standard sound system is an AM/FM stereo radio with cassette player and

FEATURES AND OPTIONS

CD changer controls for an optional, dealer-installed Mopar remote

CD changer. An available AM/FM stereo radio with cassette and single-CD

player gives you the flexibility of listening to the radio or your favorite music

on cassette or CD. All PT Cruiser sound systems are connected to six premium



standard speakers, including instrument panel-mounted tweeters, so the highs sing

through. The dome tweeters feature a neodymium magnet for high performance. Large

woofers in the front doors provide outstanding bass

response and midrange speakers in the rear pillars

balance the sound throughout the cabin. You have

a choice of three different wheels. PT Cruiser comes

standard with 15-inch all-season touring tires and bolt-on wheel covers. Included

with the available Touring Group and optional on Limited Edition are five-spoke painted

aluminum wheels. 16-inch tires and five-spoke chrome aluminum wheels are included with the Limited Edition

and available Luxury Touring Group. Chrysler accessories from Mopar

MOPAR ACCESSORIES

are another way to add a personal touch to your PT Cruiser. A Ground Effects Package adds style to an already

stylish vehicle. For the ski buff, the Six-Pair Ski Carrier adds versatility. Choose a spoiler in any of nine colors

for an aerodynamic look. All Mopar Accessories installed by your dealer at the time of vehicle purchase are



15-inch bolt-on wheel cover



Ground Effects Package from Mopar



Six-Pair Ski Carrier from Mopar



16-inch painted aluminum wheel

16-inch chrome aluminum wheel



Body-Color Spoiler from Mopar



ALL PT CRUISER MODELS INCLUDE:

- Air Bags*** — Front, Next Generation driver and front-passenger
- Air Conditioning** — Manual temperature controls
- Brakes** — Front disc/rear drum
- Brake-Park Interlock** — Cannot be shifted out of Park until brake pedal is depressed (automatic transaxle)
- Child Seat Anchorage System** — Includes user-ready child seat lower and top tether anchors
- Climate Control Outlets** — Rear, located near the rear of standard floor console
- Clock** — Digital, integral to all radios
- Clutch-Starter Interlock** — Cannot start engine until clutch is depressed (manual transaxle)
- Console** — Floor, includes four cup holders, coin holders, letter holder, cassette/CD storage, multipurpose bin, pen/pencil tray and auxiliary power outlet
- Defroster** — Electric rear window
- Door Handles** — Chrome, pushbutton-actuated
- Door Locks** — Child-protection rear
- Dynamic Side-Impact Intrusion Protection** — Includes steel side-guard door beams, unique transverse beam and structural body reinforcements
- Floor Mats** — Front and rear, carpeted
- Fuel Tank** — 15-gallon
- Glass** — Tinted sojar control
- Glove Box** — Locking
- Instrument Panel Trim** — Color-keyed inserts for Deep Cranberry, Inferno Red, Shale Green, Aquamarine and Patriot Blue. Light Pewter Metallic inserts for Taupe Frost, Bright Silver, Black and Stone White
- Instrument Cluster** — Speedometer, tachometer, odometer, trip odometer; gauges for fuel level, engine coolant temperature; warning lamps for brake system, low oil pressure, check engine, seat belts, air bags and high-beam headlamps; chimes for low fuel, door ajar, liftgate ajar; off-white faced with chrome accents
- Liftgate Handle** — Integrated into rear Chrysler winged badge
- Lighting**
 - Exterior
 - Quad-halogen headlamps
 - Taillamps with amber-color turn signals
 - Interior
 - Dome lamp with theater dimming feature
 - Cargo area lamp

Mirrors

- Exterior — Rearview, dual manual remote control
- Interior — Day/night rearview and dual visor vanity mirrors

Seats

- Front
 - Low-back buckets with driver inboard armrest and front passenger seatback storage net and two-way adjustable locking head restraints
- Rear
 - 65/35 split that can be folded, folded and tumbled or removed with quick-release, carry handles and wheels

Seat Belts — Three-point for all seating positions with height-adjustable driver and front-passenger shoulder belts, traveling inboard buckles and pretensioners

Shelf Panel — Rear, multiposition with integral grocery bag hooks

Sound System — AM/FM stereo radio with cassette player, CD changer controls and six premium speakers

Steering — Power-assisted rack-and-pinion, 18:1 ratio

Steering Column — Height-adjustable

Storage Pockets

- Front and rear doors
- Front-passenger seatback

Sun Visors — Dual, cloth-covered, sliding

Suspension

- Front
 - Independent suspension with MacPherson struts and coil springs and stabilizer bar
- Rear
 - Solid trailing arm twist-beam axle with coil springs, shock absorbers, Watt's linkage and stabilizer bar

Tire — Compact spare

Transaxle — Five-speed manual

Windows — Power with driver and front-passenger one-touch-down feature

Wiper System

- Front — Windshield, two-speed with variable intermittent mode
- Rear — Wiper/washer

*Certified to the Federal Regulations that allow less forceful air bags. Always use seat belts. Remember a backseat is the safest place for children.

CHRYSLER PT CRUISER SPECIFICATIONS†



INTERIOR DIMENSIONS

Head Room (in)	— Front	40.4
	— Rear	39.6
Leg Room (in)	— Front	41.0
	— Rear	40.6
Shoulder Room (in)	— Front	54.6
	— Rear	53.9
Hip Room (in)	— Front	54.0
	— Rear	46.8

EXTERIOR DIMENSIONS

Wheelbase (in)	103.0
Overall Length (in)	168.8
Overall Width (in)	67.1
Overall Height (in)	63.0
Track (in)	— Front 58.3
	— Rear 58.2
Coefficient of Drag	0.398
Turning Diameter (ft)	
	— 15" tires and

ENGINE SPECIFICATIONS

Drivetrain	FWD
Engine Configuration	2.4-Liter In-Line 4-Cylinder
Displacement	148.2 CID
Compression Ratio	9.5:1
Bore and Stroke (in)	3.44 x 3.98
Valve System	DOHC 16-Valve
Fuel System	Sequential Multipoint Fuel Injection
Horsepower (SAE net @ rpm)	150 @ 5,600
Torque (lb-ft @ rpm)	162 @ 4,000-

		PT Cruiser		PT Cruiser Limited Edition
Engine	Transaxle			
2.4-liter DOHC 16V 4-cylinder	5-speed Manual	27D	27F	27G
	4-speed Automatic	28D	28F	28G
Air Bags* — Side, for front outboard occupants. Includes storage net on seatbacks		O	O	●
Antilock Brake Group — 4-wheel disc antilock brakes and Low-Speed Traction Control		O	O	O
Assist Handles (4) — Outboard occupants (Included with Moonroof Group)		P	●	●
Cargo Area Net			●	●
Console — Overhead, includes dual reading lamps, digital display for compass and outside temperature (also included with the available Moonroof Group)		P	O	●
Door Locks — Power, speed-sensitive, with central locking			●	●
Engine Block Heater		O	O	O
Exhaust Tip — Chrome (included with Luxury Touring Group)			P	●
Floor Mats — "PT Cruiser" embroidered front floor mats (included with Luxury Touring Group)			P	●
Glass — Deep-tint sunscreen for rear passenger doors, rear quarter windows and liftgate		O	●	●
Light Group — Interior rearview mirror-mounted reading lamps (deleted when equipped with Overhead Console), dual illuminated visor-mounted vanity mirrors, console flood lamp, instrument panel and cargo area-mounted 12-volt power outlets		O	●	●
Lighting — Fog lamps (included with Touring Group and Luxury Touring Group)		P	P	●
Luxury Touring Group — Includes "PT Cruiser" embroidered front floor mats, leather-wrapped steering wheel, leather-wrapped shifter knob (automatic transaxle only), fog lamps, Touring Suspension, P205/55R16 All-Season Touring tires, 16" chrome-plated aluminum wheels, chrome exhaust tip, "Touring Edition" badge. (Not included on Limited Edition)			O	●
Mirrors — Dual power, heated, foldaway exterior rearview			●	●
Moonroof Group — Includes power moonroof with one-touch-open feature, Overhead Console, 4 assist handles and Light Group. (Assist handles and Light Group included in CPOS™ Package F)		O	O	●
Remote Keyless Entry — Controls for illuminated entry system, door and liftgate locks, panic alarm and Security Alarm System. Includes 2 transmitters			●	●
Roof Rack — Black with adjustable crossbars and 220-lb capacity		O	O	O
Seats				
Trim Material				
— Tipton II/Shadow II Cloth		●	●	
— Royale leather trim with Preferred Suede® accents				●
Front				
— Fold-flat passenger seat			●	●
— Driver-side power seat height adjuster			O	●
— 4-way adjustable locking head restraints				●
Rear				
— 2-way adjustable head restraints for rear outboard seating positions			●	●
Security Alarm System — Monitors doors, ignition and liftgate key cylinders			●	●
Sentry Key™ Theft Deterrent System — Engine immobilizer with 2 encoded keys			●	●
Shifter Knob — Leather-wrapped, automatic transaxle only (included with Luxury Touring Group)			P	●
Speed Control — Electronic with steering wheel-mounted controls		O	O	●
Sound System — AM/FM stereo radio with cassette and CD players		O	O	O
Steering Wheel — Leather-wrapped (included with Luxury Touring Group)			P	●
Storage Drawer* — Located under front passenger seat			●	●
Suspension — Touring (included with Touring Group and Luxury Touring Group)		P	P	●
Tires				
— P195/65R15 89T BSW All-Season Touring		●	●	
— P205/55R16 89T BSW All-Season Touring (included with Touring Group and Luxury Touring Group)		P	P	●
Touring Group — Includes fog lamps, Touring Suspension, P205/55R16 All-Season Touring tires, 16" painted aluminum wheels, "Touring Edition" badge		O	O	
Wheels				
— 15" steel with bolt-on wheel covers		●	●	
— 16" painted aluminum (included with Touring Group)		P	P	O
— 16" chrome aluminum (included with Luxury Touring Group)			P	●

*Always use seat belts. Children 12 and under should always be in a backseat correctly using an infant or child restraint system, or a seat belt that is right for their age and size. †Late availability.

● = included P = included in package noted in parentheses O = optional

If you would like to discuss vehicle details or pricing with a knowledgeable advisor before visiting your dealer, call 1-800-CHRYSLER, or visit our Web site at www.chrysler.com

Bright Silver Metallic

Shale Green Metallic

Deep Cranberry Pearl Coat

COLORS AND FABR

Patriot Blue Pearl Coat

Taupe Frost Metallic

Aquamarine Metallic

Dark Taupe

Inferno Red Tinted Pearl Coat

Black

Stone White

Dark Taupe Roy
Preferred

panel ins
ed with
colors: D
Pearl Co
Pearl Co
Metallic
Metallic
Pearl Co
colors
Pewter M

CUSTOMER ONE CARE™

At DaimlerChrysler Corporation, our commitment to complete customer satisfaction is evident in every car and minivan we sell. Long after a vehicle is driven away from the showroom, we will be there to ensure that our customers remain pleased with every new-vehicle purchase. To prove this commitment, all Chrysler vehicles are covered by the 3/36 Customer One Care™ Plan,* which includes a 3-year/36,000-mile (whichever comes first) Bumper-to-Bumper Limited Warranty† and Roadside Assistance‡ for 3 years or 36,000 miles. Roadside Assistance provides 24-hour, 7-day-a-week Emergency Road Service, contacted by a nationwide toll-free number. A 5-year or 100,000-mile Outer-Panel Rust-Through Limited Warranty covers the cost of all parts and labor needed to repair exterior sheet metal panels if perforated by corrosion. The 3/36 Customer One Care Plan stays with the vehicle, transferring automatically to subsequent owners at no cost during the warranty period.

*See your dealer for additional details and a copy of this limited warranty. †Covers the complete vehicle against defects in materials and workmanship. Excludes wiper blades, clutch disc and brake linings, brake rotors and drums, normal maintenance items (these items are covered against defects for 12 months or 12,000 miles, whichever comes first) and tires (covered by their own manufacturer's warranty). ‡Roadside Assistance services are provided by Cross Country Motor Club, Inc. (In California, Cross Country Motor Club of California, Inc.)

LEASING

Leasing is a popular way to finance a new vehicle, and the Gold Key Lease offered by Chrysler Financial Company L.L.C. has the flexibility to fit your vehicle choice and your lifestyle. Lease payments are typically lower and for a shorter term than conventional financing. At lease end, you can: 1) turn the vehicle in and lease a new one; 2) buy the vehicle and keep it; 3) buy the vehicle and sell it for a possible profit. If the idea of driving the vehicle you want and paying less for it sounds great, ask your dealer about Gold Key Lease. Gold Key Plus is a great alternative to leasing for customers who want low payments and pride of vehicle ownership—Gold Key Plus offers both. Decide how long the vehicle will be driven and the trade-in value is guaranteed (less excess mileage and wear and tear). Ask your dealer for complete details. Commercial Finance Options (CFO) offers several finance and lease options to small and midsize businesses, municipalities and small-fleet operators. A full range of automotive financing is available through Chrysler Financial, providing flexible payment plans and finance products for qualified buyers. Many of these plans can be customized to fit your particular budget and make your new vehicle even more affordable. The College Graduate Program is especially attractive to those just beginning their careers. Ask your salesperson for details about any of the above plans.

Chrysler Financial Company L.L.C. programs are offered subject to availability and state and local laws.

DAIMLERCHRYSLER SERVICE CONTRACTS

Additional protection for owners is available through optional DaimlerChrysler Service Contracts. These service plans are available in a variety of time and mileage combinations to meet your driving needs. Ask your dealer for more information or call 1-800-442-2666.

Mopar, Sentry Key and Customer One Care are trademarks of DaimlerChrysler. Preferred Suede is a registered trademark of Milliken & Co.

FOR MORE INFORMATION ON PRODUCTS
1-800-CHRYSLER or www.chrysler.com

OR LEASING:
www.chryslerfinancial.com

All product illustrations, specifications and competitive comparisons are based upon current information at the time of publication approval. Although descriptions are believed correct, complete accuracy cannot be guaranteed. DaimlerChrysler Corporation reserves the right to make changes at any time, without notice or obligation, in prices, specifications, equipment, colors and materials, and to change or discontinue models. Some of the equipment shown or described throughout this catalog is available at extra cost. See your dealer for the latest information.

Over the first 75 years, Chrysler engineering excellence became Chrysler Heritage. Within the last 10 years, Chrysler cab-forward styling has changed the architecture of the modern automobile. Simultaneously came a fine-tuning so precise that drivers, lured by the sophisticated styling, are captured by the spirited road manners. It is that perfected bonding of engineering heritage, expressive design and exacting agility that comprises the Chrysler lineup for the year 2000. The Chrysler heritage continues: with 300M, purebred descendant of the fabled 300 letter series; with Sebring, the land's best-selling convertible; with Voyager and Grand Voyager which join the luxurious Town & Country to expand upon 17 years of Chrysler minivan leadership; with the 2001 PT Cruiser, breaking the barriers of conventional design *and* function. With an entire family of elegant and able-bodied offerings that propel Chrysler innovation into the millennium.





CHRYSLER



ENGINEERED TO BE GREAT CARS